

# Sevenmiles design Roberto Lazzeroni

**Caratteristiche tecniche** - Tavolo rotondo o rettangolare realizzato in massello di noce americano o frassino. Piano in vetro 8 mm visarm o piano in multistrato impiallacciato noce americano.

**Technical features** - Round or rectangular table made in solid American walnut or ash. 8 mm visarm glass top or top in plywood veneered American walnut.

**Nota** - Specificare la finitura del vetro : trasparente, bronzato o fumé.

**Note** - Please specify glass finish : transparent, bronzed or smoked.



## Sevenmiles rotondo / round

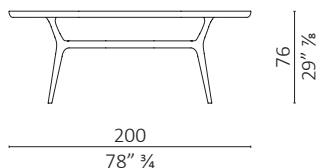
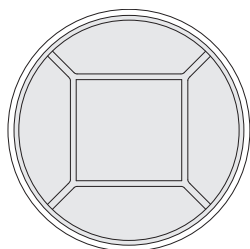

volume m<sup>3</sup> 4,838 - kg. 183

## Sevenmiles rettangolare / rectangular

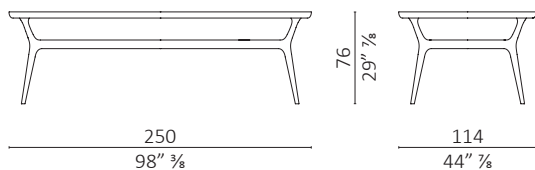
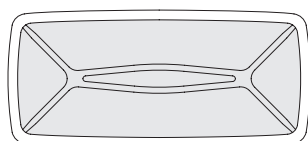

volume m<sup>3</sup> 3,581 - kg. 157

## Sevenmiles rotondo / round

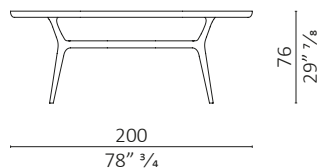
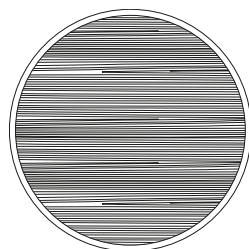

volume m<sup>3</sup> 4,442 - kg. 140

## Sevenmiles rettangolare / rectangular

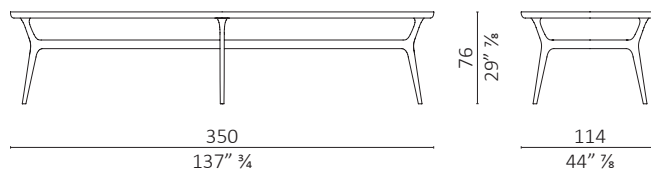
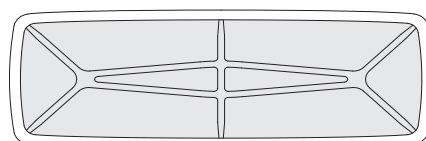

volume m<sup>3</sup> 4,946 - kg. 211

Sevenmiles rettangolare / rectangular

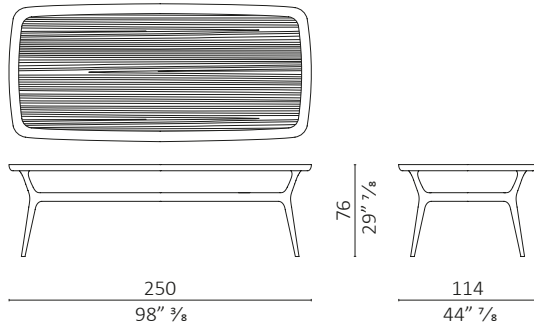

volume m<sup>3</sup> 3,328 - kg. 100

Sevenmiles rettangolare / rectangular

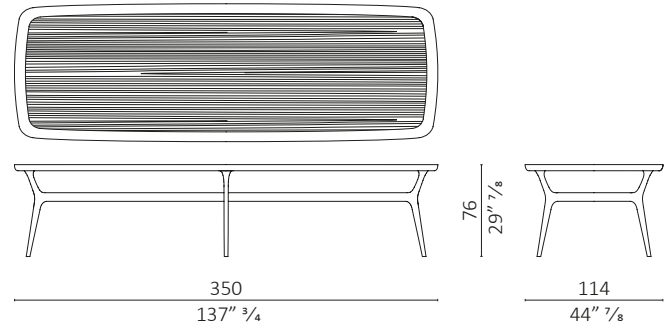

volume m<sup>3</sup> 4,592 - kg. 172

Finiture / Finiture

Legno Noce / Wood Walnut

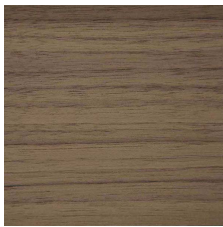

noce  
walnut



noce dark  
walnut dark



noce moka  
walnut moka



noce brown  
walnut brown

Legno Frassino / Wood Ash



frassino sbiancato  
bleached ash

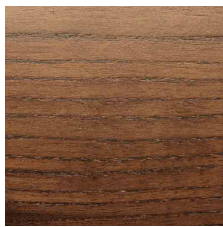

frassino dark  
ash dark

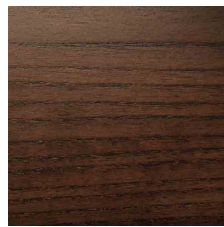

frassino moka  
ash moka

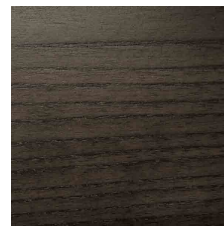

frassino brown  
ash brown

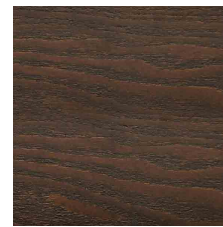

frassino wengè  
ash wengè

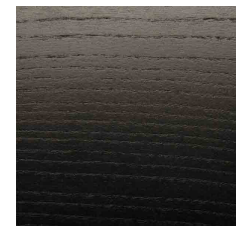

frassino black  
ash black



frassino grey  
ash grey

## Finiture / *Finiture*

### Vetro / *Glass*

---



Trasparente  
*Transparent*



Bronzato  
*Bronzed*



Fumé  
*Smoked*