

Icosofà design Roberto Lazzeroni

Caratteristiche tecniche - Divano realizzato in massello di noce americano. Scocca in multistrato di pioppo imbottita. Piedini in ottone.

Technical features - Sofa made in solid American walnut. Body in upholstered poplar plywood. Leg tips in brass.

Nota - Nella versione asimmetrica e chaiselongue, la profondità di seduta della parte più stretta è P 66 (26").

Note - In the asymmetrical and chaiselongue versions the seat depth of the narrowest part is D 66 (26").



Icosofà 233

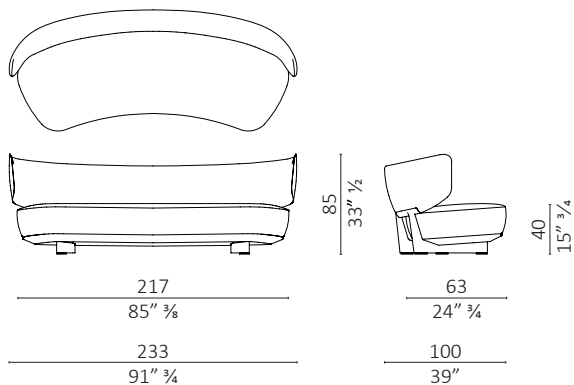

c.o.m. (l.mt.9,60/sq.mt.18,60)

Icosofà 275

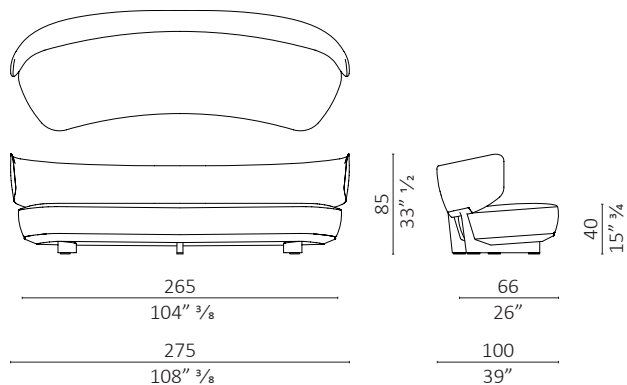

Icosofà 275 DX / RH

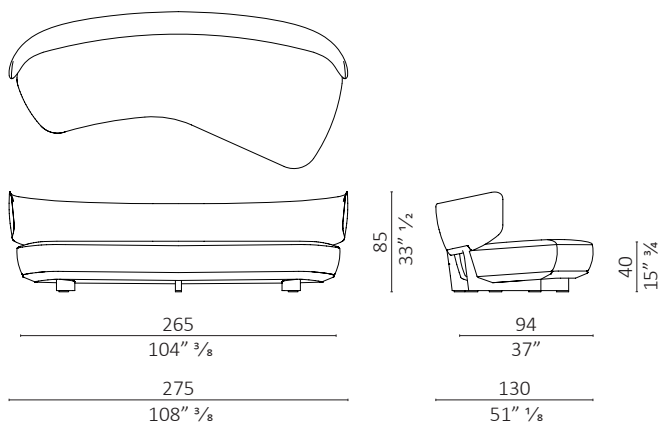

c.o.m. (l.mt.9,00/sq.mt.16,00)

Icosofà 275 SX / LH

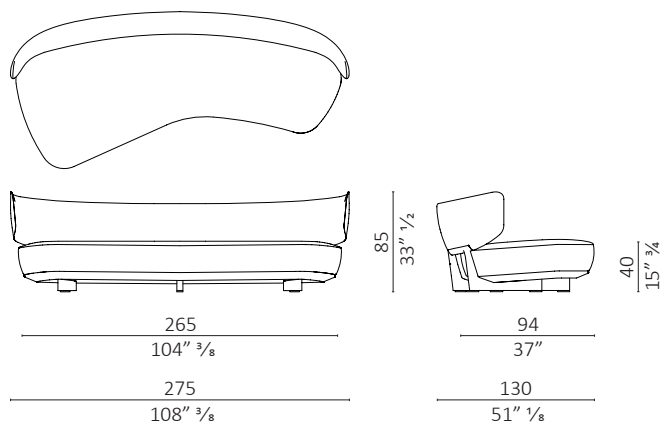

Icosofà 275 chaiselongue DX / RH

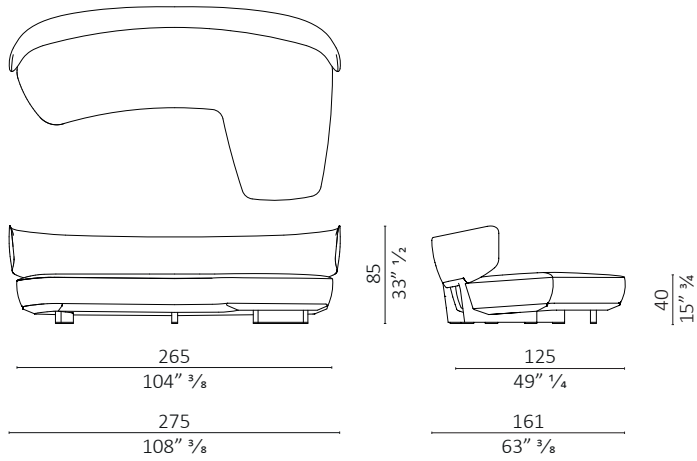

Icosofà 275 chaiselongue SX / LH

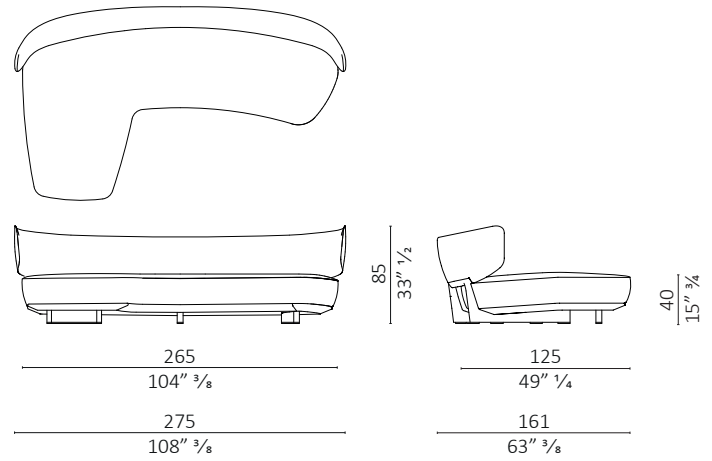

c.o.m. (l.mt.13,00/sq.mt.24,70)

Finiture / Finiture

Legno Noce / Wood Walnut



noce
walnut

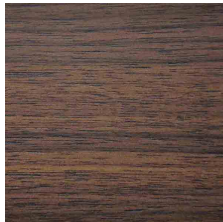

noce dark
walnut dark



noce moka
walnut moka



noce brown
walnut brown

Tessuto Velluti e Ciniglie / Fabric Velvet and Chenille

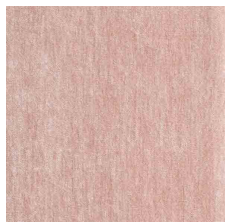

Belsuede-029



Belsuede-032

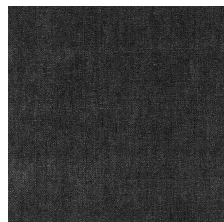

Belsuede-015



Belsuede-014



Belsuede-01

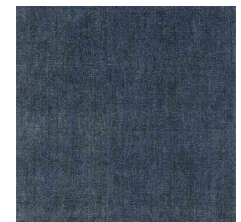

Belsuede-036

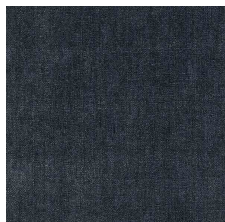

Belsuede-016

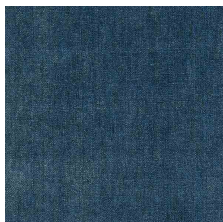

Belsuede-017

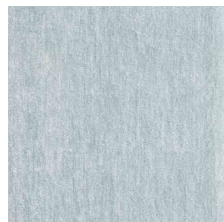

Belsuede-040

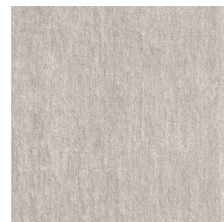

Belesuede-034

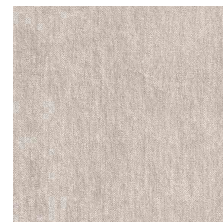

Belsuede-010

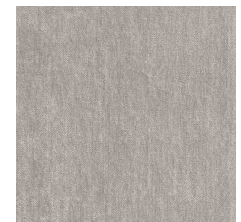

Belsuede-011

Finiture / Finiture

Tessuto Velluti e Ciniglie / Fabric Velvet and Chenille

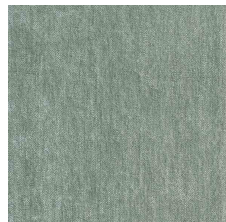

Belsuede-012

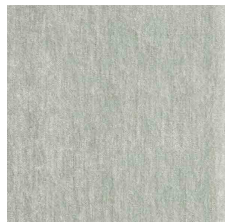

Belsuede-039

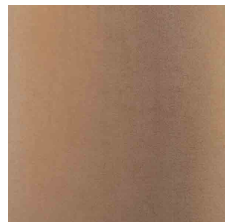

Amazonie-041

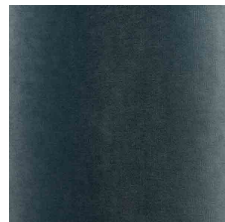

Amazonie-042

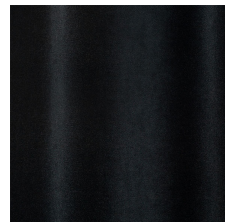

Amazonie 002

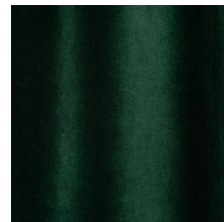

Amazonie 022

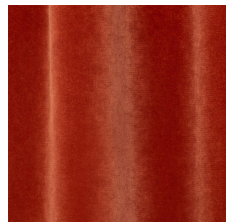

Amazonie 025

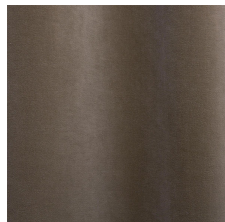

Amazonie 045



Amazonie 040

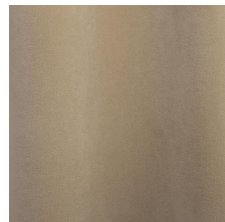

Amazonie 043



Amazonie 036

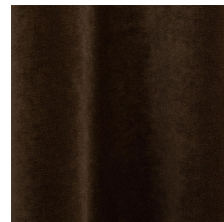

Amazonie 038

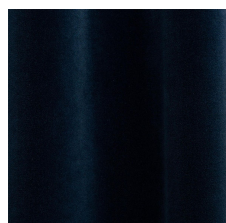

Amazonie 037

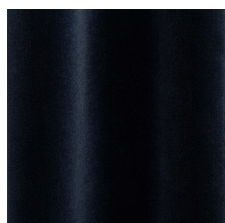

Amazonie 035

Tessuto / Fabric Bouclé



Verone Creme



Monza 00



Mies-005



Monza 09



Mies-004



Monza 07



Monza 97

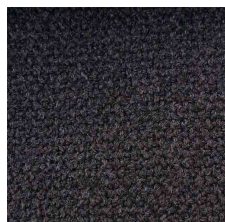

Monza 84



Monza 58



Monza 27



Monza 48



Monza 45

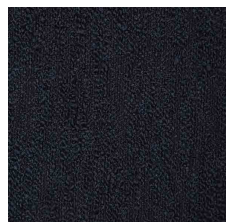

Verone Nuit



Mies-020

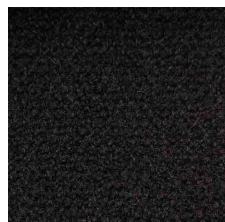

Monza 88

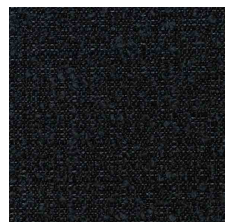

Mies-008

Finiture / Finiture

Tessuto Vari / Fabric Various

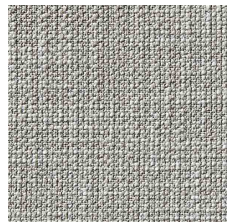

Gypsy-892

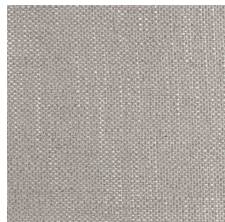

Flair-108

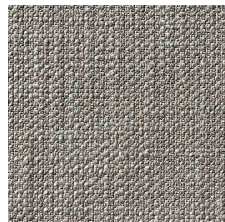

Gypsy-895



Divina 3 224

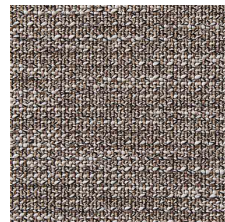

Oxford-893



Grisaille-004

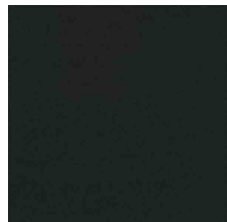

Divina 3-191

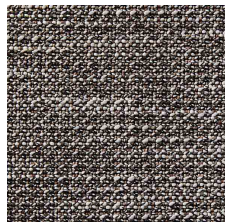

Oxford-897



Flair-121

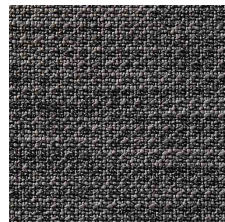

Oxford-999

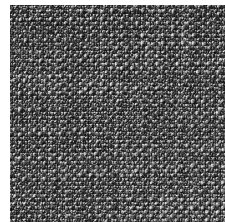

Gypsy-997

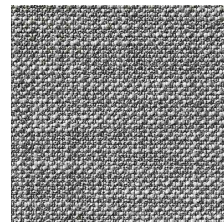

Gypsy-995

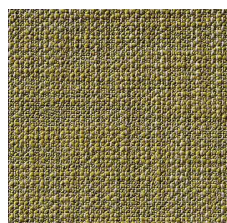

Gypsy-184

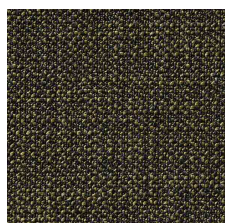

Gypsy-799



Flair 166

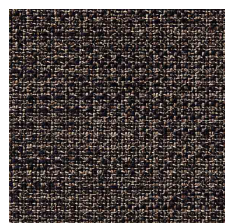

Oxford-889

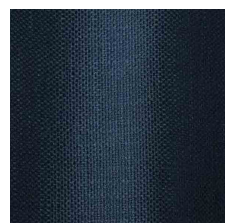

Flair-164

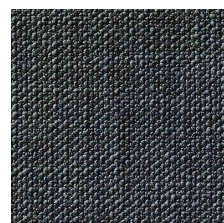

Gypsy-699

Pelle / Leather Color Sphere PF

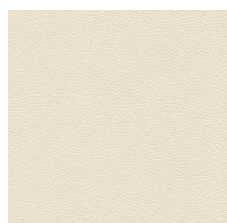

SC 06 Calicot

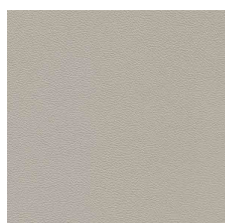

SC 23 Tortora

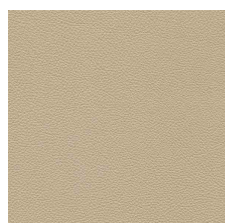

SC 32 Caolino



SC 51 Panna



SC 31 Quarzo Fumè

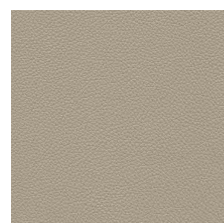

SC 34 Maggese



SC 26 Topo



SC 20 Inchiostro



SC 21 Amianto

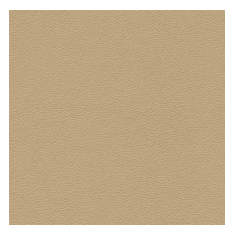

SC 53 Creta

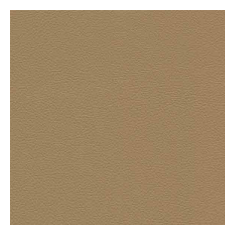

SC 55 Camel Hair

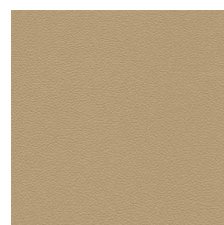

SC 52 Daino



SC 66 India

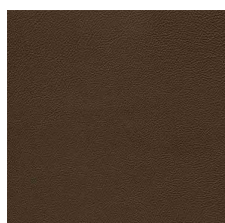

SC 59 Noce di Pecan

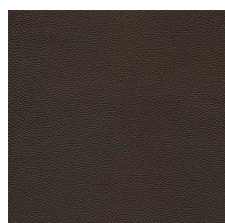

SC 80 Bruno Havana

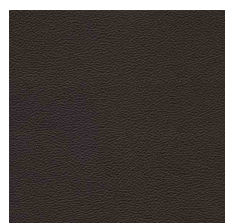

SC 29 Ardesia

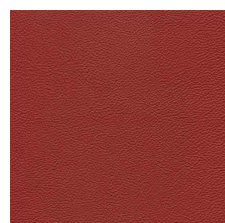

SC 148 Lacca



SC 146 Coccio Pesto

Finiture / *Finiture*

Pelle / *Leather Color Sphere PF*

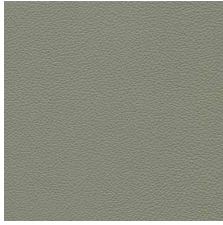

SC 173 Glauco

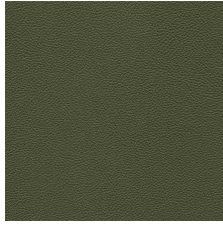

SC 177 Limo

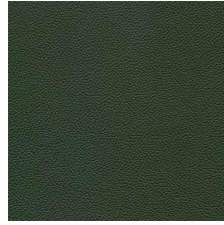

SC 178 Alpi

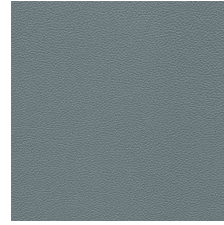

SC 254 Steel Blue

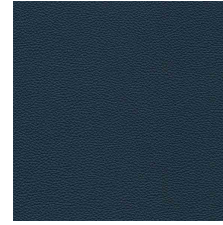

SC 278 Atlantic Blue

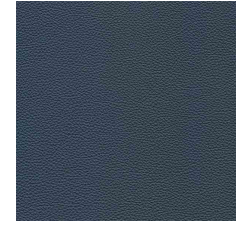

SC 279 Alchemy

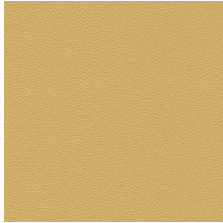

SC 133 Paglierino

Pelle naturale / *Natural leather Acquario*

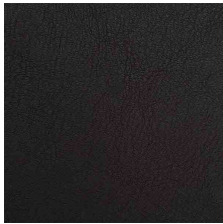

201 Testa di moro



202 Antracite



204 Fango

Pelle naturale / *Natural leather Nabuk*



Nabuk Grigio



Nabuk Conchiglia



Nabuk Seppia

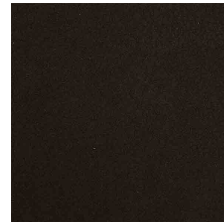

Nabuk Marrone Scuro